

2/2-way Angle-Seat Valve with weld end connection, DN 15-65



- High flow rate and long life cycle
- For hygienic connections with weld end bodies
- NC and NO universal actuators with modular universal accessory program up to control heads

Type 2000 can be combined with...



Type 8697

Electrical position feedback

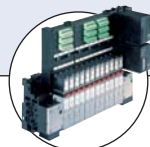

Type 8640/8644

Valve block



Type 6012/6014 P

Pilot valve

For process valves with decentralized automation see ELEMENT Type 2100



The externally piloted angle-seat valve is operated with a single or double-acting piston actuator. The actuator is available in two different materials, PA and PPS depending on the ambient temperature. The reliable self-adjusting packing gland provides high sealing integrity. High flow rates are attained with the stainless steel 2-way body.

These maintenance-free and robust valves can be retrofitted with a comprehensive range of accessories for position indication, stroke limitation or manual override.

For valves with port connection Clamp and threaded port please see separate datasheets.

1) Note: For PA actuators in the sizes 50 and 63, the combination of max. medium temperature and max. ambient temperature is as shown in the following chart

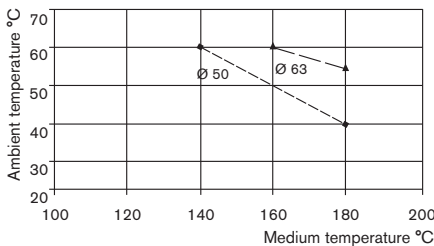

Technical data	
Orifice	DN 15 to 65
Body materials	EN ISO 1127/ISO 4200 and DIN 11850 serie 2 ASME BPE and BS 4825 Part 1
Actuator material	PA (PPS on request)
Seal material	PTFE (NBR, FKM, EPDM on request)
Medium	Water, alcohol, oils, fuel, hydraulic fluids, salt solution, alkali solutions, organic solvents, steam
Viscosity	max. 600 mm ² /s
Packing gland (with silicone grease)	PTFE V-rings with spring compensation
Medium temperature¹⁾	-10 to +180 °C with PTFE seal
Ambient temperature	PA actuator ¹⁾ -10 to +60 °C PPS actuator ¹⁾ Ø 50-80 +5 to +140 °C PPS actuator ¹⁾ Ø 100-125 +5 to +90 °C
Installation	As required, preferably with actuator in upright position
Control medium	Neutral gases, air
Max. pilot pressure	Actuator size Ø 50-80 PA and PPS 10 bar Actuator size Ø 100 PA 10 bar Actuator size Ø 100 PPS 7 bar
Port connection weld end	EN ISO 1127/ISO 4200 DIN 11850 serie 2, ASME BPE BS 4825 Part 1
Surface finish	standard Ra, internal ≤ 3.2 µm on request Internal connection area Ra ≤ 0.6 µm (external cast surface) electropolished

Content

Valve specifications	System spec. On/Off CLASSIC	Request for quotation
Type 2000 weld	Type 8801-YA	Type 8801-YA
Technical data & ordering info.	Ordering info. & technical data	
p. 1-7	p. 8-11	p. 12

Materials Type 2000 weld end

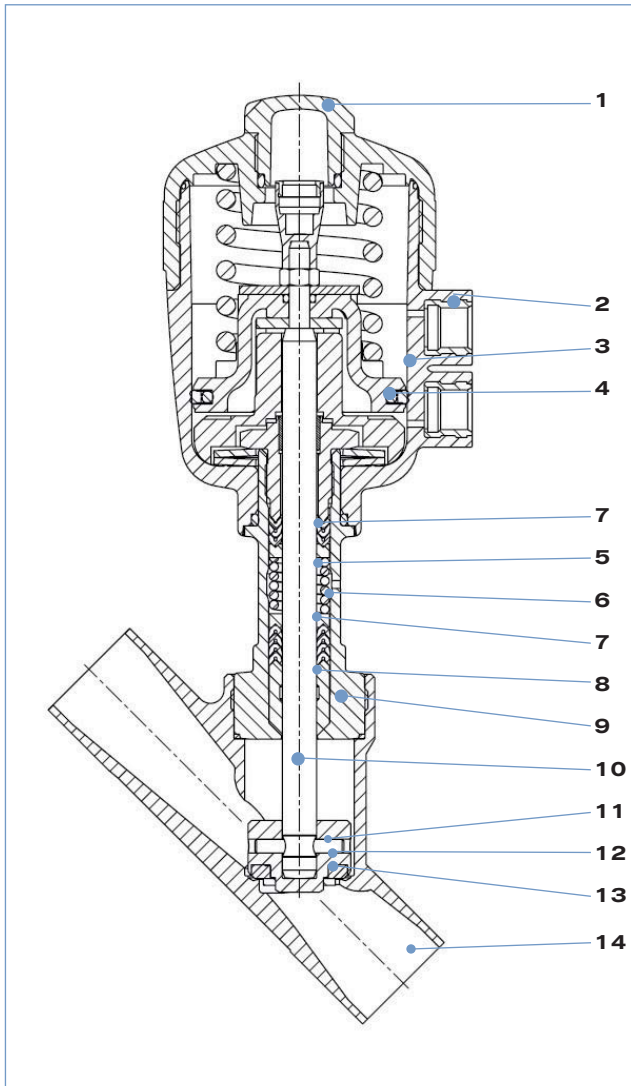

1	Transparent cap	PC (with PPS actuator; PSU)
2	Pilot air ports	Stainless steel 1.4305
3	Actuator	PA (PPS on request)
4	Piston seal	NBR (with PPS actuator; FKM)
5	Spring	Stainless steel 1.4310
6	Tube ²⁾	Stainless steel 1.4401 Stainless steel 316L ³⁾
7	V-Seals	PTFE (FKM on request)
8	Wiper	PTFE PEEK ¹⁾
9	Nipple ²⁾	Stainless steel 1.4401 Stainless steel 316L ³⁾
10	Spindle	Stainless steel 1.4401
11	Pins	Stainless steel 1.4401
12	Swivel plate	Stainless steel 1.4401
13	Seal	PTFE (NBR, FKM, EPDM on request)
14	Valve body	EN ISO 1127/ISO 4200 and DIN 11850 Series 2 Stainless steel 1.4581 (316L on request) ASME BPE/BS 4825 Part 1 Stainless steel 316L

¹⁾ For actuator size 100 mm and 125 mm

²⁾ Single piece with actuator size 63 mm to 125 mm

³⁾ For actuator size 63 mm to 125 mm

Technical data Type 2000 weld end with flow direction below seat (for gas and liquid)

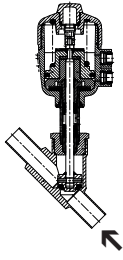

Flow direction below seat

Orifice [mm]	Actuator size [mm]	Kv value water (m ³ /h)	Min. pilot pressure CFA [bar]	Max. operating pressure up to +180°		Weight [kg]
				CFA [bar]	CFB [bar]	
15	50	4.2	3.9	16	16	0.8
20	50	8.0	3.9	11	16	1.0
25	63	19	4.2	11	16	1.8
32	63	27	4.2	6	16	2.3
	80	28	5.0	14	16	3.1
40	63	35	–	–	16	2.7
	80	38	5.0	9	16	3.5
50	63	49	–	–	13	4.0
	100	55	4.4	7.2	–	7.0
65	80	77	–	–	16	6.4
	125	90	3.2	5.2	–	11.0

Kv value water [m³/h]: Measured at +20 °C, 1 bar pressure at valve inlet and free outlet
 Pressure values [bar]: Measured as overpressure to the atmospheric pressure

Pilot pressure diagram with control function B and flow direction below seat

Diagram 1

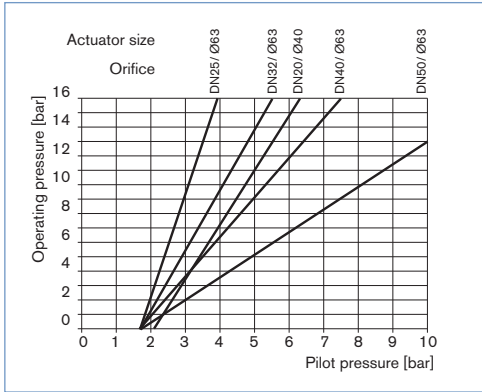
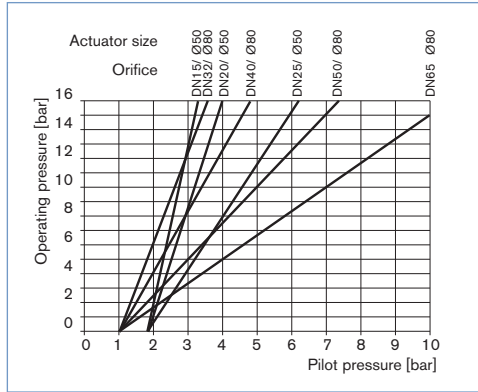

Diagram 2



Ordering chart Type 2000 weld end with flow direction below seat (further versions on request)

Actuator material PA, Ra internal/external ≤ 3.2 µm

Acc. to EN ISO 1127/ISO 4200 and DIN 11850 S2, body in stainless steel 1.4581 (316L on request)

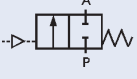
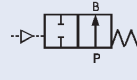
Control function	Orifice [mm]	Actuator size Ø [mm]	Port connection Weld end, tube - Ø [mm]		Min. pilot pressure [bar]	Operating pressure up to 180°C [bar]	Item no.	
			EN ISO 1127/ ISO 4200	DIN 11850 S2			EN ISO 1127/ ISO 4200	DIN 11850 Series 2
A 2/2-way, normally closed (NC) 	15	50	21.3 x 1.6	19 x 1.5	3.9	16	001 392	143 443
	20	50	26.9 x 1.6	23 x 1.5	3.9	11	001 393	143 444
	25	63	33.7 x 2	29 x 1.5	4.2	11	001 394	143 445
	32	80	42.4 x 2	35 x 1.5	5	14	001 395	143 446
	40	80	48.3 x 2	41 x 1.5	5	9	001 396	143 447
	50	100	60.3 x 2.0	53 x 1.5	4.4	7.2	274 613	143 448
B 2/2-way, normally open (NO) 	15	50	21.3 x 1.6	19 x 1.5	see diagram 1 and 2 on previous page	16	001 488	143 449
	20	50	26.9 x 1.6	23 x 1.5		16	001 489	143 450
	25	63	33.7 x 2	29 x 1.5		16	001 490	143 451
	32	63	42.4 x 2	35 x 1.5		16	001 491	143 452
	40	63	48.3 x 2	41 x 1.5		16	001 492	143 453
	50	63	60.3 x 2.0	53 x 1.5		13	274 620	143 454
65	80	76.1 x 2.3	70 x 2.0	15	168 835	169 989		

Acc. to ASME BPE and BS 4825 Part 1, body in stainless steel 316L

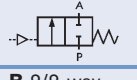
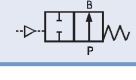
Control function	Orifice [mm]	Actuator size Ø [mm]	Port connection Weld end, tube - Ø [mm]		Min. pilot pressure [bar]	Operating pressure up to 180°C [bar]	Item no.	
			ASME BPE	BS 4825 Part 1			ASME BPE	BS 4825 Part 1
A 2/2-way, normally closed (NC) 	15	50	12.7 x 1.65	12.7 x 1.2	3.9	16	154 675	183 271
	20	50	19.05 x 1.65	19.05 x 1.2	3.9	11	183 268	183 273
	25	63	25.4 x 1.65	25.4 x 1.65	4.2	11	154 678	154 678
	40	80	38.1 x 1.65	38.1 x 1.65	5	9	154 680	154 680
	50	100	50.8 x 1.65	50.8 x 1.65	4.4	7.2	183 269	183 269
B 2/2-way, normally open (NO) 	15	50	12.7 x 1.65	12.7 x 1.2	see diagram 1 and 2 on previous page	16	154 676	183 278
	20	50	19.05 x 1.65	19.05 x 1.2		16	164 579	183 279
	25	63	25.4 x 1.65	25.4 x 1.65		16	183 270	183 270
	40	63	38.1 x 1.65	38.1 x 1.65		16	154 681	154 681
	50	63	50.8 x 1.65	50.8 x 1.65		13	174 554	174 554

i Further versions on request



Material

Seal: NBR, FKM, EPDM

Actuator: PPS

Body: Stainless steel 316L with port connection acc. to EN ISO 1127/ISO 4200 or DIN 11850 S2



Control function

Double-acting actuator



Port connections

Clamp, threaded port (see separate datasheets)



Approvals

GL, SIL



Additional

Surface finish: int. Ra ≤ 0.8 µm electro polished,
int. Ra ≤ 0.4 µm electro polished



Mediums temperature

Valves for mediums temperature up to +200 °C or down to -40 °C

Technical data Type 2000 weld end with flow direction above seat (only for gas and steam)

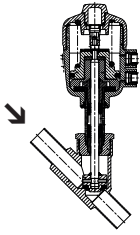

Flow direction above seat

Orifice [mm]	Actuator size [mm]	Kv value water (m ³ /h)	Max. operating pressure up to 180°	Weight [kg]
15	50	4.2	16	0.8
20	50	8.0	16	1.0
25	63	19.0	16	1.8
32	63	27.0	16	2.2
40	63	35.0	16	2.7
50	63	49.0	16	4.0
65	80	77.0	14	6.4

Kv value water [m³/h]: Measured at +20 °C, 1 bar pressure at valve inlet and free outlet
 Pressure values [bar]: Measured as overpressure to the atmospheric pressure

Attention!

Valves with flow direction above the seat are only conditionally usable for liquid medium.
 There is a danger of waterhammer!

Technical data	Flow direction above seat (only for gases and steam)
Medium	Gaseous medium and steam
Further technical data	Please see information Technical data on page 1

Pilot pressure diagram with control function A and flow direction above seat

Diagram 3

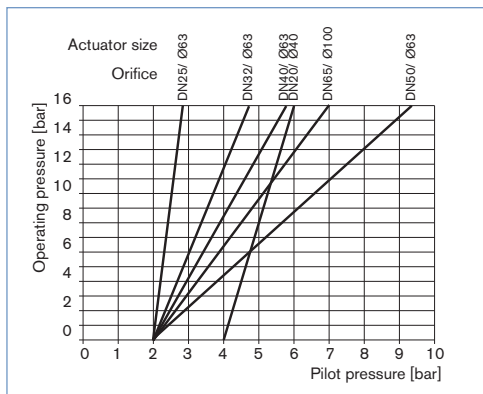
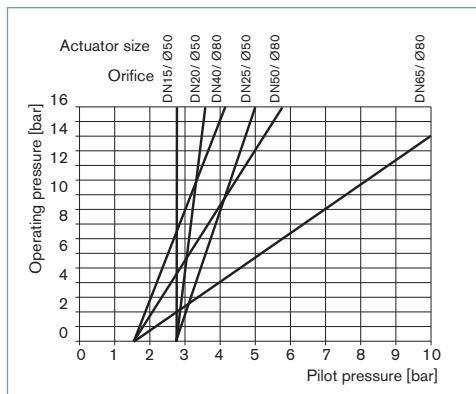

Diagram 4



Ordering chart Type 2000 weld end with flow direction above seat, only for gas & steam
(further versions on request)

Actuator material PA, Ra internal/external ≤ 3.2 µm

Acc. to EN ISO 1127/ISO 4200 and DIN 11850 S2, body in stainless steel 1.4581 (316L on request)

Control function	Orifice [mm]	Actuator size Ø [mm]	Port connection Weld end Tube - Ø [mm]		Min. pilot pressure [bar]	Operating pressure up to +180°C [bar]	Item no.	
			EN ISO 1127/ ISO 4200	DIN 11850 Series 2			EN ISO 1127/ ISO 4200	DIN 11850 Series 2
A 2/2-way, normally closed (NC) 	15	50	21.3 x 1.6	19 x 1.5	See diagram 3 and 4 above	16	001 449	143 455
	20	50	26.9 x 1.6	23 x 1.5		16	001 448	143 456
	25	63	33.7 x 2	29 x 1.5		16	001 447	143 457
	32	63	42.4 x 2	35 x 1.5		16	001 414	143 458
	40	63	48.3 x 2	41 x 1.5		16	001 415	143 459
	50	63	60.3 x 2.0	53 x 1.5		16	274 662	143 460
	65	80	76.1 x 2.3	70 x 2.0		14	431 530	171 013

Acc. to ASME BPE and BS 4825 Part1, body in stainless steel 316L

Control function	Orifice [mm]	Actuator size Ø [mm]	Port connection Weld end, tube - Ø [mm]		Min. pilot pressure [bar]	Operating pressure up to +180°C [bar]	Item no.	
			ASME BPE	BS 4825 Part 1			ASME BPE	BS 4825 Part 1
A 2/2-way, normally closed (NC) 	15	50	12.7 x 1.65	12.7 x 1.2	See diagram 3 and 4 on previous page	16	183 283	183 290
	20	50	19.05 x 1.65	19.05 x 1.2		16	183 284	183 291
	25	63	25.4 x 1.65	25.4 x 1.65		16	183 286	183 286
	40	63	38.1 x 1.65	38.1 x 1.65		16	183 288	183 288
	50	63	50.8 x 1.65	50.8 x 1.65		16	166 536	166 536

i Further versions on request



Material
Seal: NBR, FKM, EPDM
Actuator: PPS
Body: Stainless steel 316L with port connection acc. to EN ISO 1127/ISO 4200 or DIN 11850 S2



Port connections
Clamp, threaded port (see separate data-sheets)



Mediums temperature
Valves for mediums temperature up to +200 °C or down to -40 °C



Control function
Double-acting actuator



Approvals
GL, SIL



Additional
Surface finish: int. Ra ≤ 0.8 µm electro polished, int. Ra ≤ 0.4 µm electro polished

Ordering chart for accessories

3/2-way pilot valves with banjo bolts

Seal material valve FKM, seal material banjo bolt NBR

Valve for actuator size [Ø mm]	Type	Pressure inlet P (valve body)	Service port A (banjo bolt)	Orifice [mm]	Qn value air [l/min]	Pressure range [bar]	Electrical coil connection Ind. Std.	Power consumption [W]	Item no. Voltage/frequency [V/Hz] 024/DC 230/50
50-63	6012P	Tube fitting ø6 mm	G 1/4	1.2	48	0-10	Form B	4	552 283 552 286
40	6012P	G 1/4	G 1/8	1.2	48	0-10	Form B	4	552 295 552 298
50-125	6014P	G 1/4	G 1/4	2	120	0-10	Form A	8	424 103 424 107

Cable plug Type 2507, Form B or Type 2508, Form A

	Item no.
Type 2507, Form B Industrial standard, 0 to 250 V without circuitry (Type 6012 P)	423 845
Type 2508, Form A acc. DIN EN 175301-803, 0 to 250 V without circuitry (Type 6014 P, Type 0331P)	008 376

For further accessories see datasheet for Type 1062 or the accessories datasheet Type 2XXX for the full options programme.

Note: For design reasons, some of the accessories cannot be supplied for actuator size Ø 40 mm. Please request the accessories datasheet Type 2XXX.

Dimensions Type 2000 weld end [mm]

Acc. to EN ISO 1127/ISO 4200 and DIN 11850 Series 2

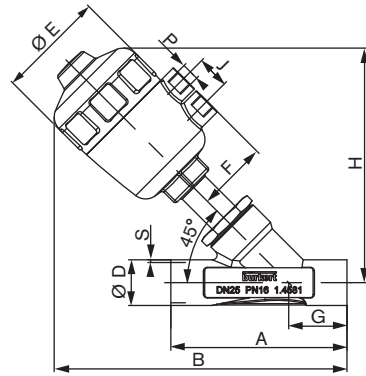

DN	Actuator size Ø	Ø E	F	P	J	B	H	A	G	Weld end body acc. to EN ISO 1127/ISO 4200		Weld end body acc. to DIN 11850 Series 2	
										Ø D	S	Ø D	S
15	50	64	44	G 1/4	24	175	141	100	34	21.3	1.6	19	1.5
20	50	64	44	G 1/4	24	184	145	115	39	26.9	1.6	23	1.5
25	63	80	52	G 1/4	24	220	177	130	43	33.7	2	29	1.5
32	63	80	52	G 1/4	24	230	185	145	45	42.4	2	35	1.5
	80	101	60	G 1/4	24	252	207						
40	63	80	52	G 1/4	24	240	191	160	49	48.3	2	41	1.5
	80	101	60	G 1/4	24	261	212						
50	63	80	52	G 1/4	24	259	209	175	50	60.3	2.0	53	1.5
	100	127	73	G 1/4	30	330	280						
65	80	101	60	G 1/4	24	292	242	210	50	76.1	2.3	70	2.0
	125	158	86	G 1/4	30	370	320						

Acc. to BS 4825 Part 1 and ASME BPE

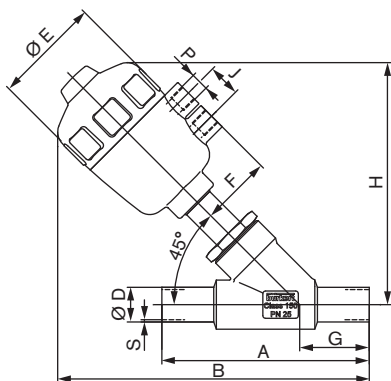

DN	Actuator size Ø	Ø E	H	F	P	J	Weld end body acc. to BS 4825 Part 1					Weld end body acc. to ASME BPE				
							A ¹⁾	B	Ø D	G	S	A ¹⁾	B	Ø D	G	S
15	50	64	145	44	G 1/4	24	135	191	12.7	46	1.2	135	191	12.7	46	1.65
20	50	64	149	44	G 1/4	24	145	201	19.05	52	1.2	145	201	19.05	52	1.65
25	63	80	178	52	G 1/4	24	152	229	25.4	51	1.65	152	229	25.4	51	1.65
40	63	80	191	52	G 1/4	24	182	251	38.1	60	1.65	182	251	38.1	60	1.65
	80	101	213	60	G 1/4	24										
50	63	80	209	52	G 1/4	24	210	273	50.8	64	1.65	210	273	50.8	64	1.65
	100	127	277	73	G 1/4	30										

¹⁾ Long version (Code AF93)

Ordering information for valve system On/Off CLASSIC Type 8801-YA

An **angle seat valve Type 2000** can be combined with the **feedback Type 8697** to form a **valve system On/Off CLASSIC**.

The valve system On/Off CLASSIC is composed of:

- a feedback **Type 8697** (see separate datasheet) [More info.](#)
- an angle seat valve **Type 2000** (see ordering chart p. 3)

For the configuration of further valve systems please use the "Request for quotation" on p. 10. [go to page](#)

You order two components and receive a complete assembled and certified valve.

Angle seat valve Type 2000 clamp



Feedback Type 8697



Valve System On/Off CLASSIC



**Type 8801-YA-U
2100 + 8697**

Electrical position feedback

[More info.](#)



Type 8697

Actuator size 40 to 225

The pneumatic control unit Type 8697 is designed for integrated mounting on CLASSIC series 20XX process valves suiting the requirements of hygienic process environment. Mechanical or inductive limit switches register the position of the valve.

Features

- Compact design
- LED position indicator
- Mechanical or inductive limit switches for end position registering
- Easy to clean chemically resistant housing featuring IP65 / IP67, 4X Rating
- Optional intrinsically safe version acc. to ATEX

Benefits

- Easy and quick installation
- High level of signal reliability thanks to self adjusting limit switches
- Signal safety through the automatic adjustment of the limit switches
- Minimised space requirement in the plant piping for more flexibility in plant design

Click on the orange box „More info“... you will come to our website for the resp. product where you can download the data sheet.

Dimensions for valve system On/Off CLASSIC Type 8801-YA [mm]

Dimensions valve system On/Off CLASSIC Type 8801-YA-U with electrical position feedback Type 8697

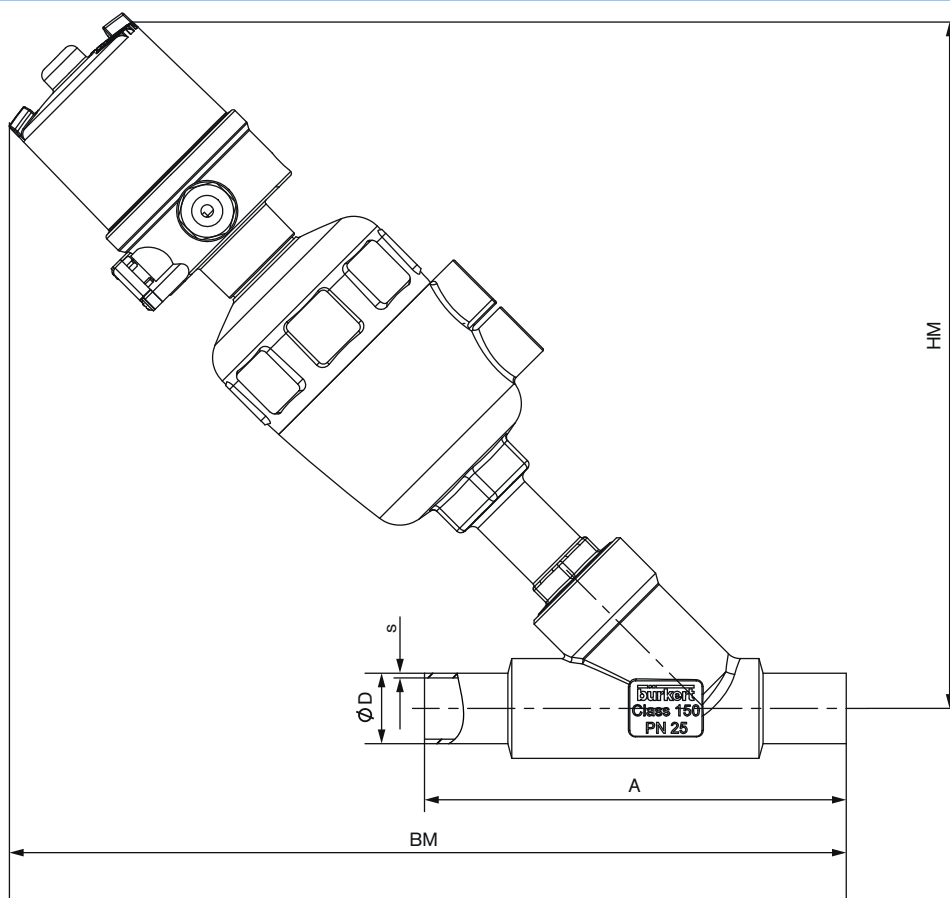

Connection	Orifice [mm]	Actuator size [mm]	BM [mm]	HM [mm]	A	ØD	s
welded DIN 11850	15	50	247	214	100	19	1,5
	20	50	257	219	115	23	1,5
	25	63	292	250	130	29	1,5
	32	80	316	277	145	35	1,5
	40	80	325	277	160	41	1,5
	50	100	391	342	175	53	1,5
welded EN ISO 1127 / ISO 4200	15	50	250	217	100	21.3	1.6
	20	50	260	222	115	26.9	1.6
	25	63	292	250	130	33.7	2
	32	80	319	277	145	42.4	2
	40	80	328	280	160	48.3	2
	50	100	382	334	175	60.3	2
welded BS 4825	15	50	266	220	135	12.7	1.2
	20	50	277	225	145	19.05	1.2
	25	63	301	251	152	25.4	1.65
	40	80	339	280	182	38.1	1.65
welded ASME BPE	15	50	266	220	135	12.7	1.2
	20	50	277	225	145	19.05	1.2
	25	63	301	251	152	25.4	1.65
	40	80	339	280	182	38.1	1.65
	50	100	405	342	210	50.8	1.65

Valve system On/Off CLASSIC Type 8801-YA – request for quotation

Please fill out and send to your nearest Bürkert facility* with your inquiry or order

Company	Contact person
Customer no.	Department
Address	Tel./Fax
Postcode/town	E-Mail

= mandatory fields to fill out

Quantity

Required delivery date

Operating data

Pipeline	DN	<input type="text"/>	PN	<input type="text"/>
Pipe material	<input type="text"/>			
Process medium	<input type="text"/>			
Type of medium	<input type="checkbox"/> Liquid	<input type="checkbox"/> Steam	<input type="checkbox"/> Gas	
	standard	unit		
Flow rate (Q, Q _N , W) ¹⁾	<input type="text"/>	<input type="text"/>		
Temperature at valve inlet	<input type="text"/>	<input type="text"/>		
Absolute pressure at valve inlet	<input type="text"/>	<input type="text"/>		

¹⁾ standard unit: Liquid Q = m³/h; Steam W = kg/h; Gas Q_N = Nm³/h

Valve features

Actuator material	<input type="checkbox"/> PA	<input type="checkbox"/> PPS
Body material	<input type="checkbox"/> Stainless steel	<input type="checkbox"/> Gunmetal
Seat sealing material	<input type="checkbox"/> PTFE <input type="checkbox"/> NBR	<input type="checkbox"/> Other <input type="text"/>
Nominal pressure	PN <input type="text"/>	
Nominal size	DN <input type="text"/>	
Type of connection	<input type="checkbox"/> Welded <input type="checkbox"/> Internal thread <input type="checkbox"/> Clamp	
Standard connection	<input type="checkbox"/> ISO <input type="checkbox"/> DIN <input type="checkbox"/> ANSI <input type="checkbox"/> JIS <input type="checkbox"/> Other <input type="text"/>	
Function	<input type="checkbox"/> NC ²⁾ <input type="checkbox"/> NO ²⁾ <input type="checkbox"/> Double-acting	
Pilot pressure	<input type="text"/> min.	<input type="text"/> max.

²⁾ NC: normally closed by spring action; NO: normally open by spring action

Automation unit features

Click on the orange box „More info“... you will come to our website for the resp. product where you can download the data sheet.

Electrical position feedback

Type 8697
For actuator size 40 to 225



- LED position indicator
- Mechanical or inductive limit switches for end position registering
- Housing with IP65/IP67, 4X rating protection
- Optional intrinsically safe version acc. to ATEX / IECEx

Position feedback switches

- Micro switch 24V DC
- Micro switch 50 – 225 V DC/AC
- Inductive switch 3-wire PNP
- Inductive switch 2-wire NAMUR
- Inductive switch 2-wire 24V DC

Electrical connection

- Cable gland
- M12 connector
(applicable only with inductive switch 3-wire PNP)

Number of Position feedback switches

- 2x

Approval

- ATEX cat. 3GD, IECEx
- ATEX cat. 2DG, IECEx
- without

Valve system On/Off CLASSIC Type 8801-YA – request for quotation, *continued*

Valve accessories	
Pilot valve	Stroke limitation
<input type="checkbox"/> Pilot valve	<input type="checkbox"/> Stroke limitation
Power supply <input type="text"/>	<input type="checkbox"/> Min./max. stroke limitation , with visual position indicator
	<input type="checkbox"/> Max. stroke limitation , without visual position indicator
Please specify item no. if known: <input type="text"/>	Please specify item no. if known: <input type="text"/>

Certifications
<input type="checkbox"/> Attestation of compliance with the order EN-ISO 10204 2.1
<input type="checkbox"/> Test report EN-ISO 10204 2.2
<input type="checkbox"/> Certification of Conformity for Raw Material EN-ISO 10204 3.1
<input type="checkbox"/> EN161 (European Gas Device guideline)

Comment / sketch

DTS 1000100996 EN Version: R Status: RL (released | freigegeben | valide) printed: 24.10.2016

*To find your nearest Bürkert facility, click on the orange box → www.burkert.com